

What You Will Need:

- Cartridge pleat tape (STW33). You need about 2 1/2 times drapery rod width
- Your chosen drapery fabric; if desired, drapery lining
- Matching thread
- Drapery weights (x4, one for each corner of each drapery panel)
- Two-prong curtain hooks (DP20)



If desired, iron the tape at synthetic setting only. Excess heat will damage the tape.

Estimate Fabric Requirement:

1. Calculate the total number of fabric widths needed:
Multiply the drapery rod width by 2.25, divide the answer by the fabric width, round the answer up to the nearest full number.
2. Calculate the drapery panel cut length:
Add 1/2" for folded back at the header, 8" for a double folded bottom hem and 1" shrinkage allowance (Total 9 1/2") to the finished drapery panel length.
Add one pattern repeat if pattern match is required.
3. Total fabric requirement:
Multiply the drapery panel cut length by the number of fabric widths needed. Convert the answer to yardage.

Example:

Rod width is 44"; finished drapery panel length is 72". Fabric width is 54" with 6" pattern repeat.

The total number of fabric widths needed is $44" \times 2.25 \div 54 = 1.8$, round up to 2. Each drapery panel will be made of one width of fabric.

The drapery cut length is $72" + 9 1/2" = 81 1/2"$.

Add the pattern repeat, $81 1/2" + 6" = 87 1/2"$.

The total fabric requirement is $87 1/2" \times 2 \div 36 = 5$ yards.

Sewing Instructions:

1. Cut and sew the panels, finish side and bottom hems. At the header, fold a 1/2" flap to the back side and press.

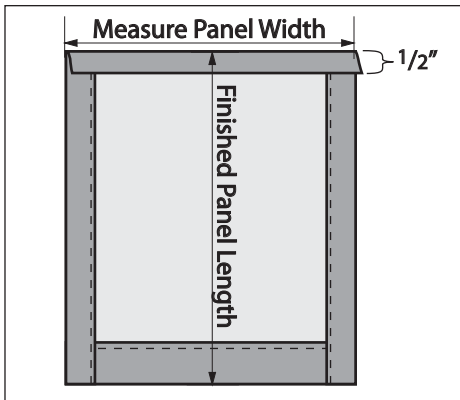

2. Measure the panel width. Cut a strip of cartridge pleat tape 2 times the panel width, plus 8" extra.

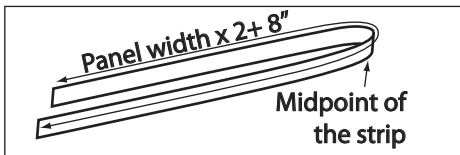

At the midpoint of the strip, find one repeat defined by two sets of woven-in repeat indicating dots. Through the center of that repeat, cut the tape into two strips, one strip for each panel.

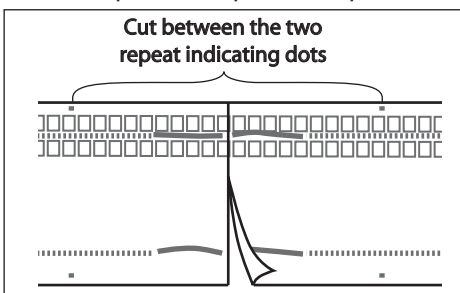

3. Remember, the two just cut tape ends will be located at where the two edges of drapery panels meet (at the center of the drapery rod). On both tape strips, next to the just cut end, double knot each loose draw cord, trim the tape 1" away from the knots.

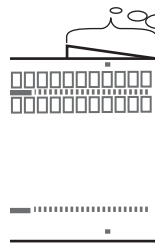
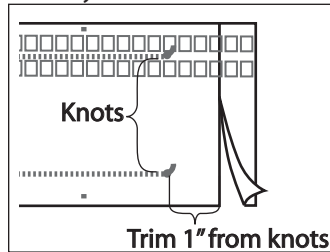

If the drapery rod has an overlap arm, turn the tape 1 1/4" under. This leaves 4" overlap.

If the panels butt together at the center, turn the tape 2 3/4" under. This leaves 2 1/2" leading edge.

4. Ensure that the pocket rows on the tape are facing up and towards the top, the turned edge matches the panel overlap (or butting) edge, place the tape across the panel, leaving 1/8" between the top edges of the tape and the panel. Pin.

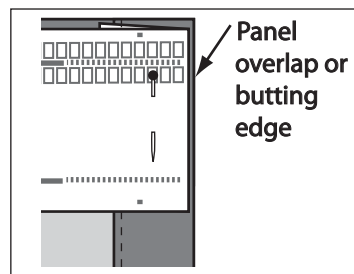

5. At the outer edge of the panel (opposite from the overlap or butting edge), trim the tape to 1" beyond the edge of the panel. Tie loose draw cords together for later pleating. If cords are not exposed, find a set of repeat indicating dots closest to the edge, use an opened paper clip to pluck the draw cords out and tie. Turn the tape 1" under.

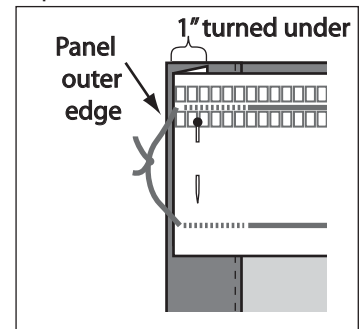

6. Machine stitch the tape to the panel along the green sewing lines. Stitch both edges of the tape in the same direction. Be careful not to sew over the draw cords.

Pleating Instructions:

1. Hold the tied together cords in one hand or tie them to a door knob, gently push the first pleat into position. Advance to push and form the second pleat. Return to the first pleat, as this is no longer pleated, and re-pleat. Advance to form next pleat, return to re-pleat the flattened pleats. Repeat until all the pleats along the whole panel are pleated. Make sure there is no puckering between the pleats. Go back to adjust, if necessary.

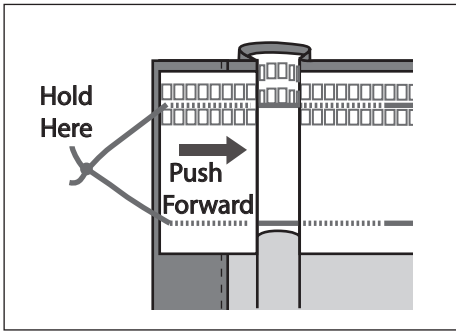

Do not cut off the excess cords. Wind the loose cords to make a neat bundle. Catch the cord bundle with two stitches to the panel.

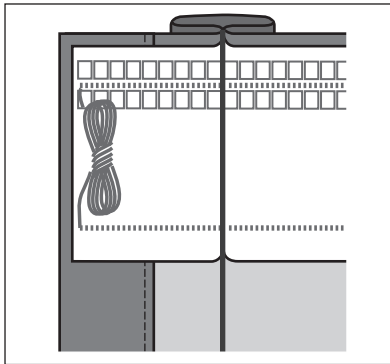

2. Insert a two-prong curtain hook at the back of each pleat. Insert the two prongs into adjacent two pockets and flip the hook on itself, as shown.

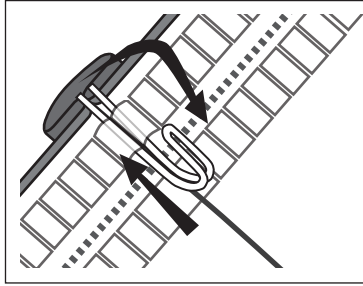

Insert two-prong curtain hooks at both edges of the panel for overlap and return.

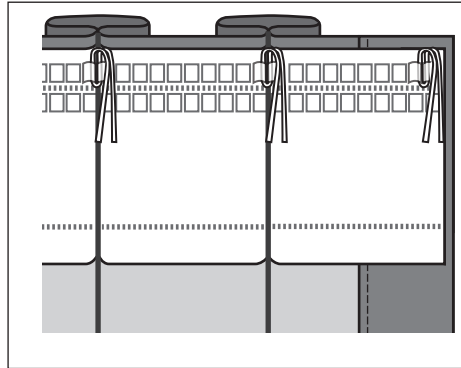

3. Hang the panels by inserting both prongs through eyes of pole rings or glides.